

# Data Sheet



Article number: 03445060

Description: Fluro Heavy Duty Spherical Plain Bearing GE 60 EW-2RS  
Hole Ø60

Note: 60

## Measures

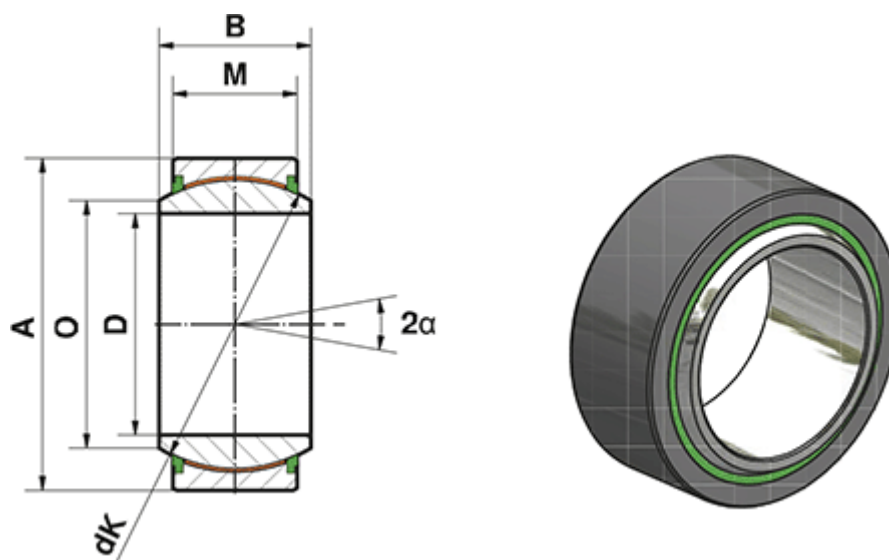

A	= 90	Static load C0 (kN) = 1150
a (degrees)	= 6	Weight (g) = 980
B	= 44	
D	= 60	
dk	= 80	
Dynamic load C (kN)	= 690	
M	= 36	
O	= 66.8	